

Turmdrehkran

Tower Crane / Grue à tour / Gru a torre / Grúa torre
Guindaste de torre / Башенный поворотный кран

280 HC-L 16/28 Litronic®

280 HC-L 12/24

280 HC-L 16/28

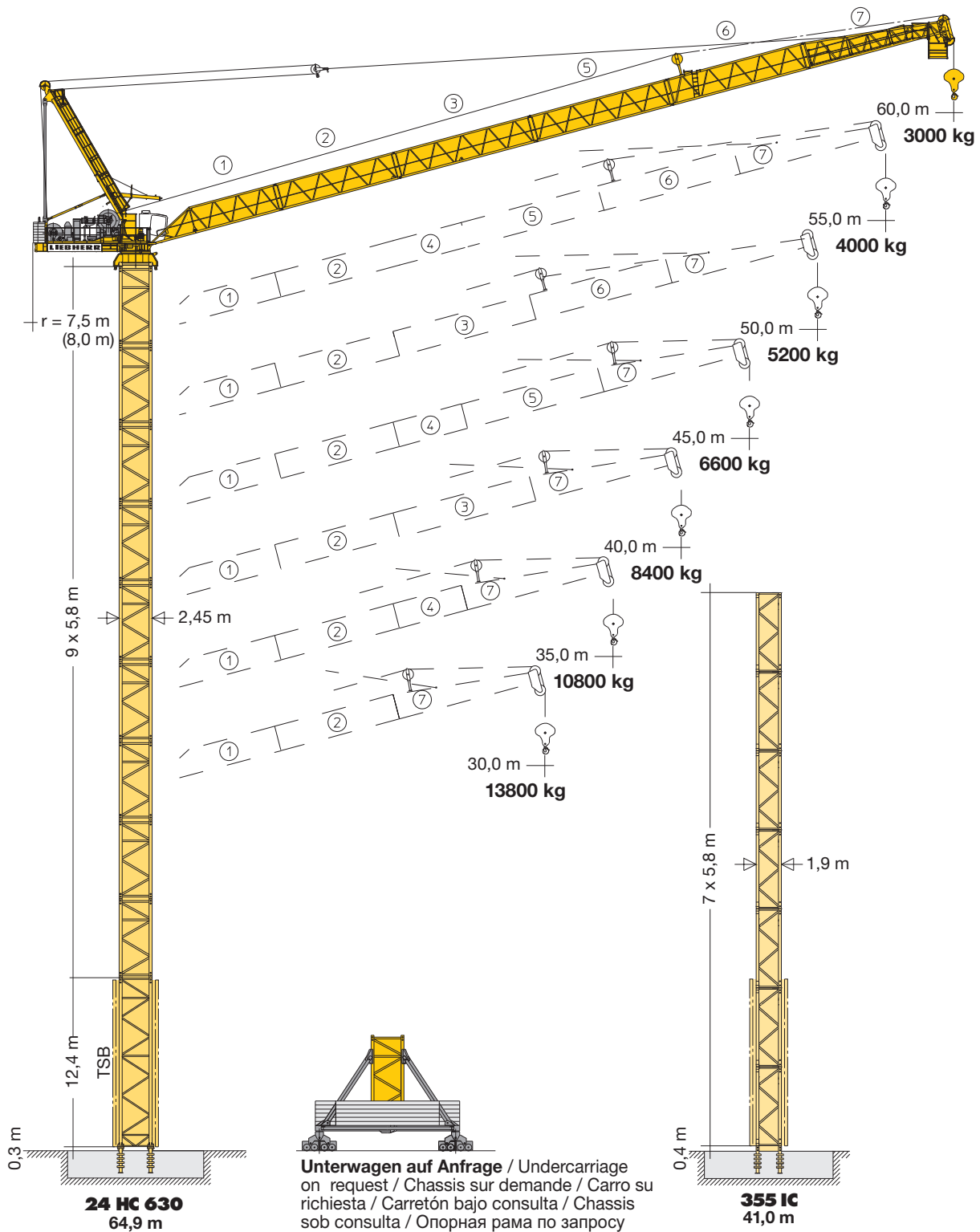

LN 303

LIEBHERR

Ausladung und Hubhöhe

Radius and hoisting height / Portée et hauteur de levage / Sbraccio e altezza di sollevamento / Alcance y altura de elevación / Alcance e altura de elevação / Вылет и Высота подъема

Minimum Ausladung außer Betrieb

Minimum radius out of operation
Portée minimum hors service
Sbraccio minimo fuori servizio
Alcance mínimo fuera de servicio
Alcance mínimo fora de operação
Минимальный вылет вне работы

Ausleger (m) Jib / Flèche Braccio / Pluma Lança / Стрела	Außenbetriebsstellung (α°) Out-of-operation position Position hors service Posizione fuori servizio Posición externa de la empresa Posição fora de operação Положение вне работы			
355 IC 24 HC 630	α	∫ (m)	ϕ (m)	
60	72°	20,7	-	
55	72°	19,1	18,6	
50	73°	16,7	16,2	
45	72°	15,9	15,4	
40	71°	15,0	14,5	
35	70°	13,9	13,4	
30	65°	14,6	14,1	

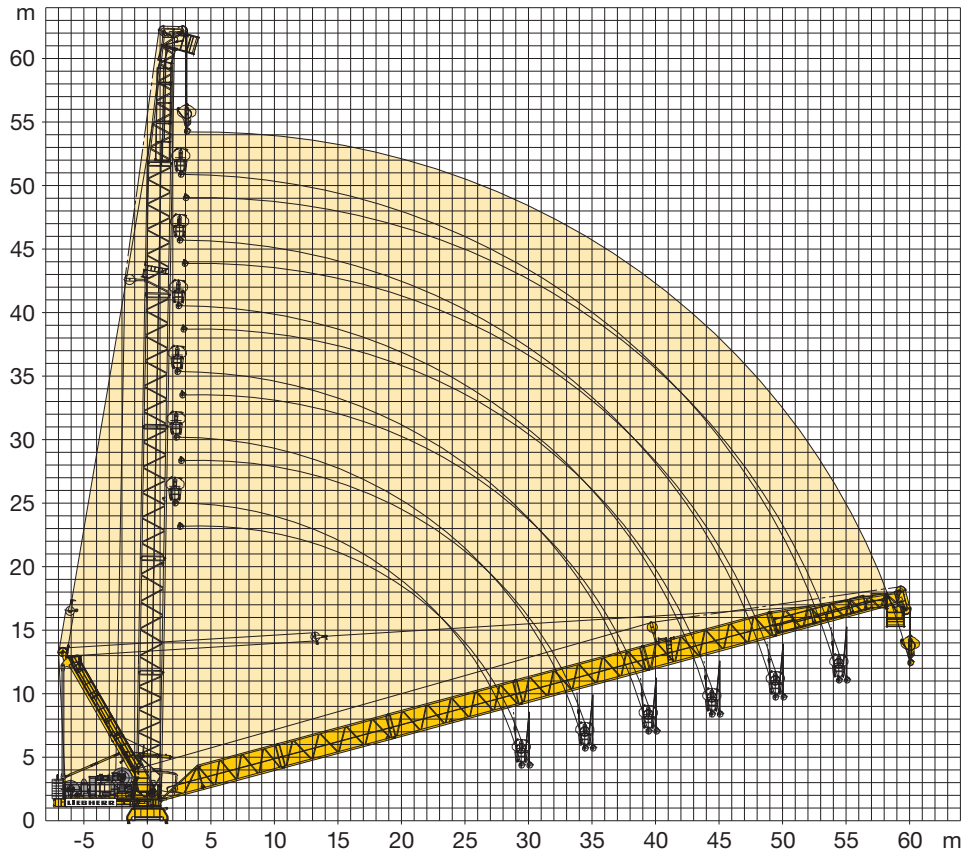

Turmhöhen

Tower heights / Hauteur de mât / Altezze torre / Alturas de torre / Alturas de torre / Высота башни

LN 303	24 HC 630					355 IC								
	Ausleger / Jib / Flèche / Braccio / Pluma / Lança / Стрела													
	30,0 m	35,0 m	45,0 m	50,0 m	60,0 m	30,0 m	40,0 m	50,0 m	55,0 m	60,0 m	30,0 m	45,0 m	50,0 m	60,0 m
12	70,0 ¹⁾	-	-	-	-	-	-	-	-	-	-	-	-	-
11	64,2	64,2 ¹⁾	-	-	-	76,5 ¹⁾	-	-	-	-	-	-	-	-
10	58,4	58,4	58,4 ¹⁾	-	-	70,7	70,7 ¹⁾	-	-	-	-	-	-	-
9	52,6	52,6	52,6	52,6 ¹⁾	52,6 ¹⁾	64,9	64,9	64,9	64,9 ¹⁾	-	52,6 ¹⁾	-	-	-
8	46,8	46,8	46,8	46,8	46,8	59,1	59,1	59,1	59,1	59,1	46,8	46,8 ¹⁾	-	-
7	41,0	41,0	41,0	41,0	41,0	53,3	53,3	53,3	53,3	53,3	41,0	41,0	41,0 ¹⁾	-
6	35,2	35,2	35,2	35,2	35,2	47,5	47,5	47,5	47,5	47,5	35,2	35,2	35,2	35,2
5	29,4	29,4	29,4	29,4	29,4	41,7	41,7	41,7	41,7	41,7	29,4	29,4	29,4	29,4
4	23,6	23,6	23,6	23,6	23,6	35,9	35,9	35,9	35,9	35,9	23,6	23,6	23,6	23,6
3	17,8	17,8	17,8	17,8	17,8	30,1	30,1	30,1	30,1	30,1	17,8	17,8	17,8	17,8
2	12,0	12,0	12,0	12,0	12,0	24,3	24,3	24,3	24,3	24,3	12,0	12,0	12,0	12,0
1	6,2	6,2	6,2	6,2	6,2	18,5	18,5	18,5	18,5	18,5	6,2	6,2	6,2	6,2
0	0,4	0,4	0,4	0,4	0,4	12,7	12,7	12,7	12,7	12,7	0,4	0,4	0,4	0,4

24 HC 630		355 IC	





Ausladung und Tragfähigkeit

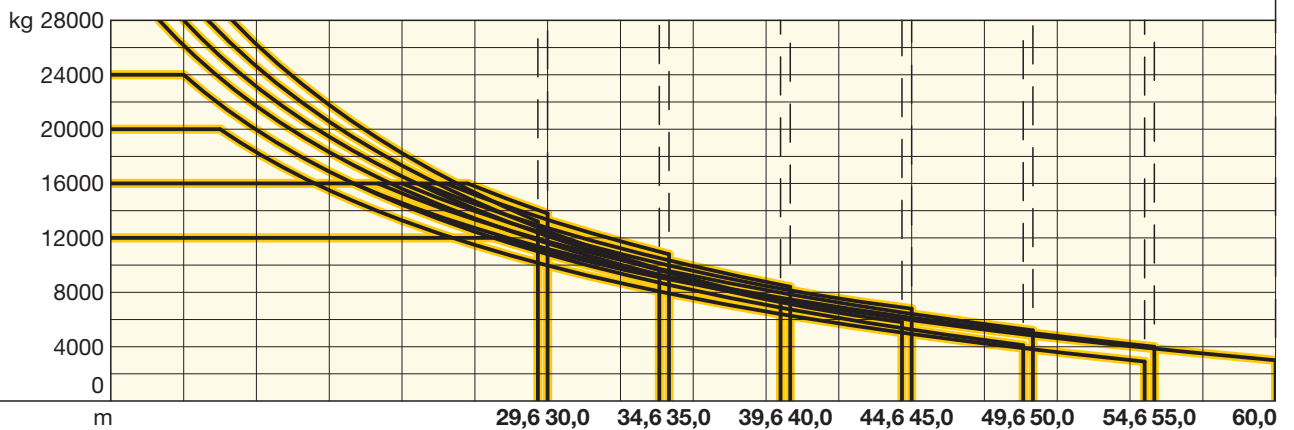

Radius and capacity / Portée et charge / Sbraccio e portata
Alcances y cargas / Alcance e capacidade de carga / Вылет и грузоподъемность

m	m/kg	m/kg											
		15,0	18,0	21,0	24,0	27,0	30,0	35,0	40,0	45,0	50,0	55,0	60,0
60,0	3,4 – 28,0 12000	12000	12000	12000	12000	12000	11010	8950	7310	5960	4830	3860	3000
55,0	3,4 – 22,0 16000	16000	16000	16000	14560	12730	11200	9130	7480	6130	4990	4000	
	3,4 – 16,5 20000	20000	18300	15500	13290	11480	9970	7920	6280	4930	3800	54,6 m 2900	
50,0	3,4 – 23,0 16000	16000	16000	16000	15270	13350	11740	9570	7840	6420	5200		
	3,4 – 15,0 24000	24000	19940	16870	14440	12460	10790	8540	6740	5250	49,6 m 4100		
45,0	3,4 – 24,0 16000	16000	16000	16000	16000	13970	12270	9970	8130	6600			
	3,4 – 14,0 28000	26160	21690	18300	15620	13430	11600	9110	7120	44,6 m 5600			
40,0	3,4 – 24,8 16000	16000	16000	16000	16000	14490	12730	10340	8400				
	3,4 – 15,0 28000	28000	23130	19440	16520	14130	12130	9420	39,6 m 7400				
35,0	3,4 – 25,8 16000	16000	16000	16000	16000	15170	13340	10800					
	3,4 – 16,0 28000	28000	24610	20550	17330	14700	12490	34,6 m 9700					
30,0	3,4 – 26,7 16000	16000	16000	16000	16000	15790	13800						
	3,4 – 17,0 28000	28000	26230	21770	18230	15330	29,6 m 13200						

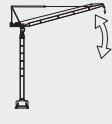



Tragfähigkeiten gültig bis 100 m Hubhöhe. Über 100 m Hubhöhe reduziert sich die Tragfähigkeit um das zusätzliche Seilgewicht. / Lifting capacities valid up to 100 m hoisting height. Over 100 m hoisting height, the lifting capacity is reduced by the additional rope weight. / Capacités de levage valables jusqu'à 100 m de hauteur sous crochet. Au-dessus de 100 m de hauteur sous crochet, la capacité de levage est réduite du poids de câble supplémentaire. / Portate valide fino a 100 d'altezze di sollevamento. Oltre i 100 m si riduce la portata causa il peso addizionale della fune. / Cargas válidas hasta altura de 100 m. Por encima de los 100 m se reduce la carga por el peso adicional del cable. / Cargas válidas ate à altura de 100 m. Para alem dos 100 m, reduz-se a carga pelo peso adicional do cabo. / Грузоподъемность действительна до 100 м высоты подъема. Свыше 100 м высоты подъема грузоподъемность сокращается на вес дополнительного каната.

	U/min 0 ↔ 0,7 sl./min tr./min	2 x 7,5 kW FU
	1,7 min	110 kW FU
	Unterwagen auf Anfrage / Undercarriage on request / Chassis sur demande / Carro su richiesta / Carretón bajo consulta / Chassis sob consulta / Опорная рама по запросу	

	110 kW FU
	110 kW FU
kVA	212,0

kVA reduzierbar bei zu geringer Netz-Anschlussleistung, siehe BAL.
 kVA can be reduced in case of too little power of the mains, see instruction manual. / kVA peut être réduit en cas de trop faible puissance du réseau, voir manuel d'instruction. / kVA riducibili in caso di potenza di rete ridotta (si veda manuale uso e manutenzione) / kVA variable para potencia de red demasiado pequeña, ver Manual de instrucciones. / kVA reduzível no caso de capacidade da rede elétrica muito baixa, ver manual de instruções. / Количество кВА может быть сокращено до минимальной общей потребляемой мощности, см. инструкцию по эксплуатации.



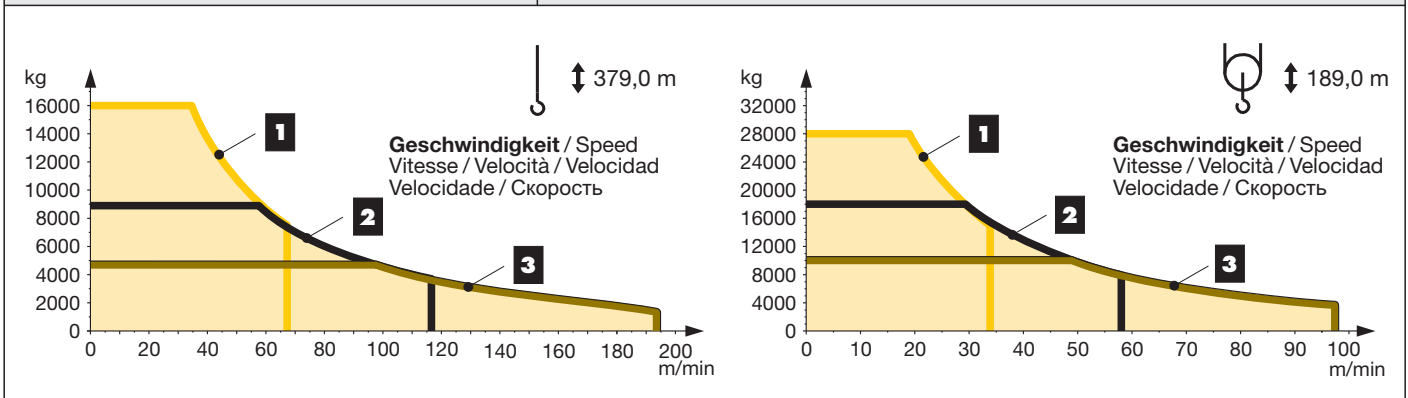

























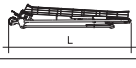

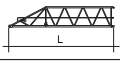



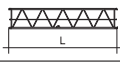

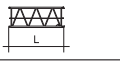

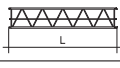

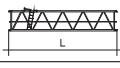
		↔ stufenlos / stepless / régl. continu / regl. progressiva / sin escalones sem degraus / бесступенчатый			
	max. 1143 m	kg	m/min	kg	m/min
110 kW FU WIW 300 VZ 406	4 Lagen / Layers Couches / Avvolgimenti Camadas / Capas / Слоёв	1	16000 0 ↔ 34	1	28000 0 ↔ 17
			7500 0 ↔ 67		15500 0 ↔ 34
		2	8900 0 ↔ 58	2	18300 0 ↔ 29
		3	3600 0 ↔ 116	3	8000 0 ↔ 58
			4700 0 ↔ 97		10000 0 ↔ 49
			1100 0 ↔ 194		3900 0 ↔ 97



LN 303		355 IC					
n	Ausleger / Jib / Flèche / Braccio / Pluma / Lança / Стрела						
	30,0 m	35,0 / 40,0 / 45,0 / 50,0 m	55,0 / 60,0 m	30,0 m	35,0 / 40,0 / 45,0 / 50,0 m	55,0 / 60,0 m	
8	h	52,6	-	-	h	52,2	-
7		46,8	46,8	-		46,4	-
6		41,0	41,0	41,0		40,6	40,6
5		35,2	35,2	35,2		34,8	34,8
4		29,4	29,4	29,4		29,0	29,0
3		23,6	23,6	23,6		23,2	23,2
2		17,8	17,8	17,8		17,4	17,4
1		12,0	12,0	12,0		11,6	11,6
0	m	6,2	6,2	6,2	m	5,8	5,8

LN 303		24 HC 630						
n	Ausleger / Jib / Flèche / Braccio / Pluma / Lança / Стрела							
	30,0 m	35,0 / 40,0 m	45,0 / 50,0 / 55,0 m	60,0 m	30,0 / 35,0 m	40,0 / 45,0 / 50,0 m	55,0 / 60,0 m	
10	h	70,0	-	-	-	h	69,6	-
9		64,2	64,2	-	-		63,8	-
8		58,4	58,4	58,4	-		58,0	58,0
7		52,6	52,6	52,6	52,6		52,2	52,2
6		46,8	46,8	46,8	46,8		46,4	46,4
5		41,0	41,0	41,0	41,0		40,6	40,6
4		35,2	35,2	35,2	35,2		34,8	34,8
3		29,4	29,4	29,4	29,4		29,0	29,0
2		23,6	23,6	23,6	23,6		23,2	23,2
1		17,8	17,8	17,8	17,8		17,4	17,4
0	m	12,0	12,0	12,0	12,0	m	11,6	11,6

²⁾ **Min. Verankerungshöhe kann bei max. Turmhöhe bzw. bei Hakenhöhe > 100m abweichen.** / Min. anchoring height may deviate at max. tower height resp. hook height > 100 m. / La hauteur d'ancrage min. peut différer en cas de hauteur de mât max. resp. en cas de hauteur sous crochet > 100m. / In caso dell'altezza max torre/gancio, l'altezza min. di ancoraggio può differire di > 100m. / La altura mínima de arriostamiento puede variar con una altura máxima de torre, es decir para alturas bajo gancho > 100m. / Em uma torre, com uma altura do gancho > 100 m a altura mín. do ancoramento pode variar. / Мин. высота крепления к зданию может изменяться при макс. высоте башни или при высоте крюка более 100м.

Kranoberteil		Upper part of crane / Partie supérieure de grue / Parte superiore della gru Parte superior grúa / Parte superior do guindaste / Верхняя часть крана	L (m)	B (m)	H (m)	kg ³⁾			
Pos. Item Rep. Voce Pos. Ref. Pos.	Anz. Qty. Qte. Qta. Cant. Cant. Кол-во	Drehbühne mit KUD-Auflage / Slewing platform with slewing ring support / Ensembles mât cabine avec pivot cage / Plataforma girevole con supporto della ralla di rotazione / Plataforma giratória con suporte de coroa dentada / Asiento pista con plataforma giratoria / Поворотная платформа с рамой ОПУ			355 IC	2,97	2,32	2,56	9290
1	1				24 HC 630	3,05	2,32	2,57	11350
2	1	Getriebebühne mit Einzieh- und Hubwerk ⁴⁾ / Machinery platform with luffing and hoist gear ⁴⁾ / Plate-forme des mécanismes avec méc. de relevage et de levage ⁴⁾ / Piattaforma meccanismi con argano di sollevamento braccio e argano di sollevamento ⁴⁾ / Plataforma de mecanismos con mecanismo de cambio de alcance y mecanismo de elevación ⁴⁾ / Plataforma de mecanismos com mecanismos de basculamento da lança e de elevação ⁴⁾ / Лебедочная платформа со стрелоподъемным механизмом и грузовой лебедкой ⁴⁾				6,74	2,75	2,98	16240
3	1	Getriebebühne mit Einziehwerk, ohne Hubwerk / Machinery platform with luffing gear, without hoist gear / Plate-forme des mécanismes avec méc. de relevage, sans méc. de levage / Piattaforma meccanismi con argano di sollevamento braccio, senza argano di sollevamento / Plataforma de mecanismos con mecanismo de cambio de alcance, sin mecanismo de elevación / Plataforma de mecanismos com mecanismo de basculamento da lança, sem mecanismo de elevação / Лебедочная платформа со стрелоподъемным механизмом, без грузовой лебедки				6,74	2,18	2,48	11430
4	1	Hubwerkseinheit ⁴⁾ / Hoist gear unit ⁴⁾ / Treuil de levage ⁴⁾ / Gruppo meccanismo sollevamento ⁴⁾ / Mecanismo de elevación ⁴⁾ / Grupo de mecanismo elevatório ⁴⁾ / Блок грузовой лебедки ⁴⁾				3,02	2,71	1,38	4810
5	1	Kabine mit Podest / Cabin with platform / Cabine avec plate-forme / Cabina con pedana / Cabina con plataforma / Cabina com plataforma / Кабина с площадкой				5,24	1,94	2,55	1850
6	1	Seitenpodest rechts / Side platform / Plate-forme latérale / Pedana laterale / Plataforma lateral / Plataforma lateral / Боковая платформа справа				2,15	1,17	0,77	100
7	1	Seitenpodest links / Side platform / Plate-forme latérale / Pedana laterale / Plataforma lateral / Plataforma lateral / Боковая платформа слева				3,77	0,90	0,82	180
8	1	Seitenpodest rechts / Side platform / Plate-forme latérale / Pedana laterale / Plataforma lateral / Plataforma lateral / Боковая платформа справа				5,41	1,10	0,82	270
9	1	Auslegerhaltebock / Jib retaining frame / Chevalet de retenue de flèche / Cavalletto tirante braccio / Caballete de soporte de pluma / Cavalette de suporte da lança / Кронштейн стрелы				11,95	2,20	2,34	5180
10	1	Ausleger-Anlenkstück / Jib heel section / Pied de flèche / Sezione articolata braccio / Pluma tramo primero / Base articulada de lança / Корневая секция стрелы				11,23	1,87	2,04	① 1750
11	1	Ausleger-Zwischenstück / Intermediate jib section / Élément intermédiaire de flèche / Sezione intermedia braccio / Tramo intermedio pluma / Peça suplementar da lança / Промежуточная секция стрелы				9,20	1,83	1,98	② 1360
12	1	Ausleger-Zwischenstück / Intermediate jib section / Élément intermédiaire de flèche / Sezione intermedia braccio / Tramo intermedio pluma / Peça suplementar da lança / Промежуточная секция стрелы				10,55	1,83	1,98	③ 1500
13	1	Ausleger-Zwischenstück / Intermediate jib section / Élément intermédiaire de flèche / Sezione intermedia braccio / Tramo intermedio pluma / Peça suplementar da lança / Промежуточная секция стрелы				5,18	1,83	1,98	④ 850
14	1	Ausleger-Zwischenstück / Intermediate jib section / Élément intermédiaire de flèche / Sezione intermedia braccio / Tramo intermedio pluma / Peça suplementar da lança / Промежуточная секция стрелы				10,35	1,83	1,98	⑤ 1330
15	1	Ausleger-Zwischenstück / Intermediate jib section / Élément intermédiaire de flèche / Sezione intermedia braccio / Tramo intermedio pluma / Peça suplementar da lança / Промежуточная секция стрелы				10,35	1,83	2,32	⑥ 1430
16	1	Ausleger-Kopfstück / Jib head section / Pointe de flèche / Punta braccio / Tramo punta de pluma / Cabeça de lança / Концевая секция стрелы				11,23	2,23	2,46	⑦ 2720
17	1	Unterflasche / Bottom hook block / Moufle inférieure / Bozzello inferiore / Polipasto inferior / Gincho inferior / Крюковая обойма				1,47	0,73	1,89	1710
Ballast		Ballast / Lest / Zavorra / Lastre / Lastro / Балласт							
18	1	Stahlballast / Steel ballast / Lest en acier / Contrappeso di acciaio / Lastres metálicos / Lastro metálico / Металлический балласт				4,40	0,31	0,88	4870
19	1	Stahlballast / Steel ballast / Lest en acier / Contrappeso di acciaio / Lastres metálicos / Lastro metálico / Металлический балласт				4,40	0,27	0,88	2940
Kleinteile		Small parts / Accessoires / Accessori / Accesorios / Acessórios / Мелкие детали							
20	1	Seile, Kleinteile / Ropes, small parts / Câbles, accessoires / Funi, accessori / Cables, accesorios / Cabos, acessórios / Канаты, мелкие детали							4500

³⁾ Einzelgewichte. / Single weights. / Poids individuels. / Singoli pesi. / Tramo punta de pluma / Pesos de peças componentes. / Индивидуальный вес.

⁴⁾ Hubwerk ohne Sekundärbremse / Hoist gear without secondary brake / Mécanisme de levage sans frein secondaire / Argano di sollevamento senza freno ausiliario / Mecanismo de elevación sin freno secundario / Mecanismo de elevação sem freio secundário / Грузовая лебедка без вторичного тормоза

Konstruktionsänderungen vorbehalten! / Subject to alterations! / Sous réserves de modifications! / Riservato il diritto di modifiche strutturali! / ¡Sujeto a modificaciones! / Salvo modificação da construação! / Права на внесение конструкторских изменений сохраняются!

Sämtliche Angaben erfolgen ohne Gewähr. / This information is supplied without liability. / Ces renseignements sont sans garantie. / Tutte le indicazioni fornite senza garanzia. / Declinamos toda responsabilidad derivada de la información proporcionada. / Declinamos qualquer responsabilidade quanto à informação fornecida. / Все данные указаны без обязательств.